

User Manual

Touchscreen Series

Models

7TS7M/U1–32TS7M/U1
8TSV7M/U1–19TSV7M/U1
10HB9M/U1–27HB9M/U1

Language
Version
Date

English
1.5.1
03-03-2026

Table of Contents

1. Scope and Intended Use	4
1.1 Professional Component Classification	5
1.2 Intended Audience	5
1.3 Scope of Documentation and Allocation of Responsibility	5
1.4 Product Traceability	6
1.5 Language and Documentation Availability	6
2. Safety Information	7
2.1 Safety Symbols and Signal Words	8
2.2 Electrical Safety	8
2.3 Power Supply and Electrical Components	8
2.4 Restrictions on Use in Safety-Critical Systems	9
2.5 Environmental and Handling Precautions	9
2.6 Accessories and Modifications	9
2.7 General Safety Instructions	9
3. Mechanical Installation & Mounting	10
3.1 Delivery Inspection and Package Contents	11
3.2 Installation Site Requirements	12
3.3 Mounting Methods	13
3.4 Compass Safe Distance (Maritime Installations)	18
4. Electrical & System Integration	20
4.1 Power Supply Requirements	21
4.2 DC Power Integration	21
4.3 Grounding and Isolation	21
4.4 Signal Connections	21
4.5 Initial Installation & Connection Overview	22
4.6 Foreseeable Misuse and Integration Risks	22
5. Operation & Control	23
5.1 Remote Control	24
5.2 Physical Control Buttons	25
5.3 OSD Menu	27
5.4 Touch Functionality & OS Compatibility	33
6. Maintenance, Cleaning & Burn-in Prevention	34
6.1 Maintenance and Handling Guidelines	35
6.2 Cleaning Instructions	35
6.3 Image Retention (Burn-In) Prevention	35
6.4 Environmental Operating Limits	35
7. Troubleshooting & FAQ	36
7.1 Troubleshooting	37
7.2 Frequently Asked Questions (FAQ)	39
8. Regulatory Notices	40
8.1 FCC Compliance (United States)	41
8.2 ISED Compliance (Canada)	41
8.3 Regional Compliance Scope	41
8.4 System-Level Regulatory Responsibility	41
8.5 Regulatory Contact Information	41
9. Warranty & Contact Information	42
9.1 Limited Warranty	43
9.2 Warranty Exclusions	43
9.3 Limitation of Liability	43
9.4 Service and Support Contacts	44
10. Appendix	45



Scope and Intended Use

1. Scope and Intended Use

» *This chapter defines the intended application context of the product, the professional audience for whom this manual is written, and the allocation of responsibilities between Beetrionics and the system integrator.*

1.1 Professional Component Classification

This product is classified and supplied exclusively as an unintegrated professional display component. It is engineered for integration into commercial and industrial environments by professional entities.

The product is not supplied as a finished consumer device and is not intended for standalone consumer use. It is designed to be integrated into a broader system architecture by qualified professionals.

1.2 Intended Audience

This manual is intended for professional users, including qualified electrical and mechanical installers, system integrators, engineering departments, and Original Equipment Manufacturers (OEMs). Electrical and mechanical integration shall be performed by qualified professionals in accordance with the requirements of the final application, applicable standards, and local regulations.

1.3 Scope of Documentation and Allocation of Responsibility

This component-level documentation as presented in the User Manual is provided to support professional system integration and evaluation activities. It describes the display component in its delivered configuration.

This manual does not represent approval, certification, or suitability of any complete system or end-use application, including but not limited to vehicles, maritime vessels, railway systems, medical devices, or other regulated installations.

Final system-level compliance, risk assessment, regulatory approval, and conformity with applicable directives or standards remain the sole responsibility of the system integrator, OEM, or end manufacturer.

The following fall outside the scope of this component-level documentation:

- Environmental conditions of the final installation.
- Enclosure design.
- Power distribution architecture.
- Grounding schemes.
- Cabling configuration.
- EMC behavior within the complete system.
- Any sector-specific certifications.

1.4 Product Traceability

The product label is located on the rear of the display enclosure. Each unit is identified by a unique serial number located on the product label. The serial number serves as the primary identifier for product traceability, warranty processing, service support, and safety-related inquiries. Users are advised to record the serial number and retain it for future reference.

Product Label Location

The example product label shown in the image below contains a fully populated regulatory configuration. Actual markings may vary depending on the specific model, hardware revision, intended market, and sector-specific approval.



1.5 Language and Documentation Availability

This manual is provided in English as the primary reference document. Safety instructions are available in the official language(s) of the country where the product is made available, in accordance with applicable regulatory requirements. Users are responsible for ensuring that the documentation used during installation and integration is appropriate for the intended market and application.

Documentation in local languages can be requested or downloaded via the Beetronics Helpcenter on the regional website for your country. A list of regional websites is available in Section 9.4.







Safety Information

2. Safety Information

» This chapter describes safety-related information that must be observed during installation, integration, operation, and maintenance of the display component. Failure to follow these instructions may result in personal injury, equipment damage, malfunction, or non-compliance of the final system.

2.1 Safety Alert Symbols and Signal Words

Safety-related information in this manual is identified by standardized signal words and symbols.

 DANGER	Danger	Imminently hazardous situation which, if not avoided, will result in death or serious injury.
 WARNING	Warning	Potentially hazardous situation which, if not avoided, could result in death or serious injury.
 CAUTION	Caution	Potentially hazardous situation which, if not avoided, could result in minor or moderate injury.
 NOTICE	Notice	Information related to property damage or operational issues. The safety alert symbol is not used with this signal word.

2.2 Electrical Safety

WARNING

Risk of Electric Shock and Fire ⚡

- Dangerous voltages may be present inside the display enclosure.
- Do not open or disassemble the display. The unit contains no user-serviceable parts.
- Do not expose the display to rain, water, or excessive humidity.
- Service and repairs must be performed by qualified personnel only.
- Failure to observe these precautions may result in serious injury or equipment damage.

2.3 Power Supply and Electrical Components

WARNING

Use of Approved Power Components Only

- Operate the display only with the power supply specified or supplied by Beetrionics for the applicable model.
- Use of unapproved or modified power supplies may introduce safety risks and affect evaluated configurations.
- For sector-specific configurations requiring defined compliance frameworks, the corresponding Beetrionics power supply must be used as specified for that configuration.

Use of unregulated or third-party DC power sources falls outside the evaluated safety configuration and is the responsibility of the system integrator.

2.4 Restrictions on Use in Safety-Critical Systems



Not a Safety Component

This display component is not designed or evaluated for use in safety-critical applications. Use in such applications could result in:

- Death or serious personal injury
- Catastrophic property damage
- Environmental damage

Examples of safety-critical applications include, but are not limited to:

- Life-supporting or life-sustaining medical systems
- Emergency or fail-safe systems
- Primary control, steering, or navigation systems
- Aviation, aerospace, nuclear, or critical defense systems

Unless explicitly agreed in writing under a formally executed agreement, Beetrionics assumes no responsibility for such use. Where integrated into a regulated system, the system integrator is solely responsible for redundancy, monitoring, and system-level certification.

2.5 Environmental and Handling Precautions

NOTICE

Operating Environment

Install and operate the display within the specified environmental limits defined in this manual. Avoid prolonged exposure to direct sunlight or high-intensity light sources to prevent discoloration or degradation. Do not block ventilation openings. Ensure adequate airflow to prevent overheating.

NOTICE

Condensation Risk

If the display is moved from a cold environment to a warmer environment, condensation may form on internal or external surfaces. Do not power on the display until condensation has fully evaporated. If condensation on internal surfaces is suspected, allow the display to acclimatize at room temperature for a minimum of 2 hours before applying power.

2.6 Accessories and Modifications

NOTICE

Approved Accessories Only

Use only accessories, mounting hardware, and components specified or recommended by Beetrionics.

Use of unapproved accessories may result in equipment damage or improper system integration.

Unauthorized Modifications

Any modification to the enclosure, electronic circuitry, firmware, or power delivery system constitutes a substantial modification.

Beetrionics assumes no responsibility for the safety, performance, or compliance of products modified by third parties.

2.7 General Safety Instructions

NOTICE

Professional Installation Required

Installation and integration must be performed by qualified personnel familiar with applicable standards and local regulations.

Read this manual carefully before installation or operation.

NOTICE

Workplace Safety and PPE

Installers and integrators shall comply with all applicable workplace health and safety regulations and procedures. Appropriate personal protective equipment (PPE) shall be used as required by the installation environment and applicable local regulations.

3

Mechanical Installation & Mounting

3. Mechanical Installation & Mounting

» This chapter defines the technical requirements for the physical integration of the display component. In accordance with the professional classification of this product, mechanical installation shall be performed by qualified personnel familiar with the requirements of the final application and installation environment.

3.1 Delivery Inspection and Package Contents

Upon receipt, inspect the shipping container for visible damage prior to opening.

Carefully unpack the display component from the shipping container and verify that all standard items shown in the package content overview below are present and undamaged.

Retain the original packaging materials for potential transport, storage, or return service.

If damage, shortages, or discrepancies are identified, do not proceed with installation. Contact the appropriate Beetronics point of contact immediately. In the event of visible transport damage, also notify the delivery carrier.

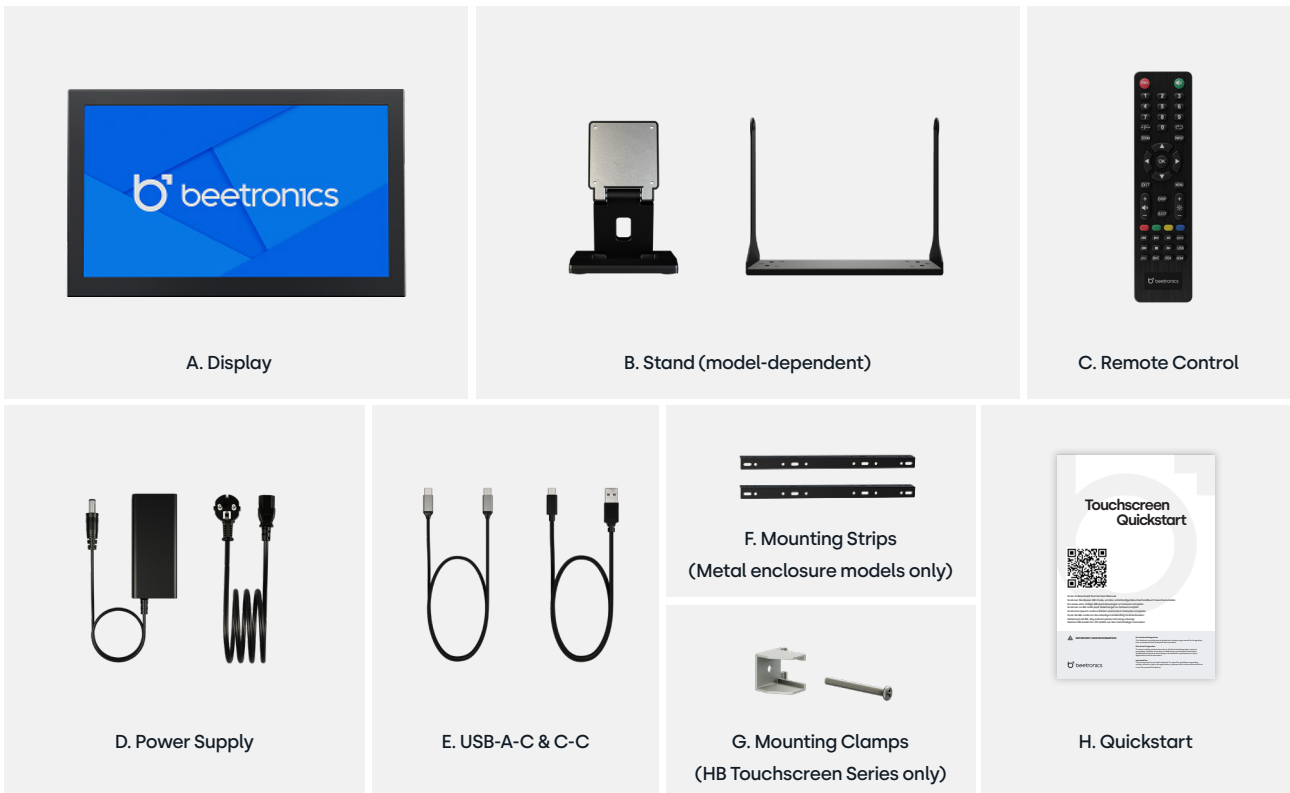

3.2 Installation Site Requirements

To ensure optimal performance, reliability, and product longevity, the installation site shall meet the following requirements.

- **Ventilation:** Do not obstruct ventilation openings. Restricted airflow may prevent proper cooling and result in overheating.
- **Thermal Limits:** Operate the display only within the specified temperature range of $-10\text{ }^{\circ}\text{C}$ to $+60\text{ }^{\circ}\text{C}$ ($14\text{ }^{\circ}\text{F}$ to $+140\text{ }^{\circ}\text{F}$).
- **Light Exposure:** Avoid prolonged installation in direct sunlight or near high-intensity heat sources. Excessive heat exposure may lead to discoloration, reduced performance, or internal damage.
- **Acclimatization:** If the display is moved from a cold environment to a warmer location, allow sufficient time for temperature stabilization. Do not apply power until all condensation has completely evaporated.

3.3 Mounting Methods

The display supports multiple professional mounting configurations depending on the model and enclosure type. All mounting hardware and installation methods must be properly rated and appropriate for the display's weight and the specific installation environment.

3.3.1 Desktop Installation (Standard Configuration)

Most Beetronics displays are supplied with a desktop support system as standard. Depending on the selected model, this consists of:

- A foldable plastic stand, or
- A metal gimbal bracket assembly



Plastic Foldable Stand

The plastic stand is attached via the rear VESA interface (75 mm or 100 mm depending on model).

The hinge mechanism requires firm force to open. This resistance is intentional and designed to ensure mechanical stability and prevent unintended tilting.

Rubber pads are located on the underside of the stand. If permanent fixation is required, the rubber pads may be removed to access integrated mounting holes for surface fastening.



Metal Gimbal Bracket

The metal gimbal bracket consists of three connected steel plates forming a rigid support assembly. The bracket is mounted to the side mounting points of the display enclosure using the pre-installed screws.

The gimbal bracket is intended to be mechanically secured to the supporting surface. Operating the display without fastening the bracket assembly may result in instability or tipping.

For all desktop installations:

- The supporting surface shall be level and mechanically stable.
- The total weight of the display and mounting assembly shall not exceed the load capacity.
- Adequate ventilation clearance shall be maintained.

3.3.2 VESA Mounting Interface

All displays are equipped with a standard VESA mounting pattern (75 mm or 100 mm, model dependent) located on the rear enclosure.

Use the four threaded mounting points to secure a compatible VESA mounting system to the display enclosure.

NOTICE

Fastener Selection

Use only mounting screws of the correct specification and length. Screws exceeding the allowable thread depth may cause internal damage to the display assembly.

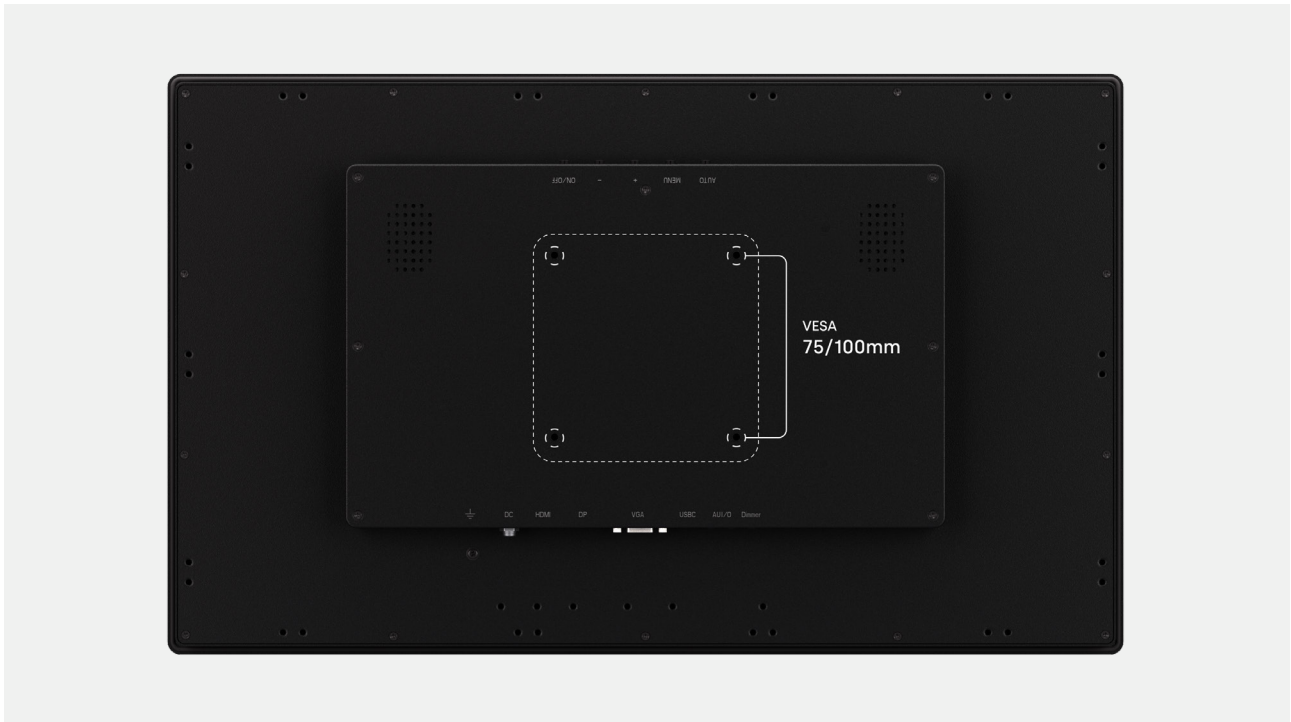

3.3.3 Wall Mounting

The display may be wall-mounted using the optional VWB1 or VWB7 bracket, or a compatible third-party VESA mounting system.



VWB1



VWB7

VWB1 & VWB7 Wall Brackets

These brackets consist of two primary components: A mounting plate that attaches to the rear VESA interface of the display.

A wall plate that mounts to the supporting structure.

Installation procedure:

- Remove the existing stand assembly.
- Secure the display mounting plate to the VESA interface.
- Secure the wall plate to the wall using anchors appropriate for the wall material.
- Attach and secure the display assembly to the wall-mounted plate.

The weight of the display must not exceed the rated load capacity of the selected bracket.

Third-Party VESA Mounts

The VESA interface may also be used with compatible mounting systems, including:

- Universal wall mounts
- Ceiling mounts
- Pole mounts
- Articulating arms

The system integrator is responsible for verifying mechanical compatibility and load capacity.

3.3.4 Flush Mounting (Metal Enclosure Models Only)

Flush mounting is supported exclusively on models with a metal enclosure. These models are supplied with L-shaped steel mounting brackets. The brackets may be installed in two configurations:

Installation requirements:

- Mounting surface shall provide sufficient structural rigidity.
- Adequate ventilation clearance must be maintained.
- Only original enclosure mounting points shall be used.

Flush mounting is not supported on plastic enclosure models unless otherwise specified.

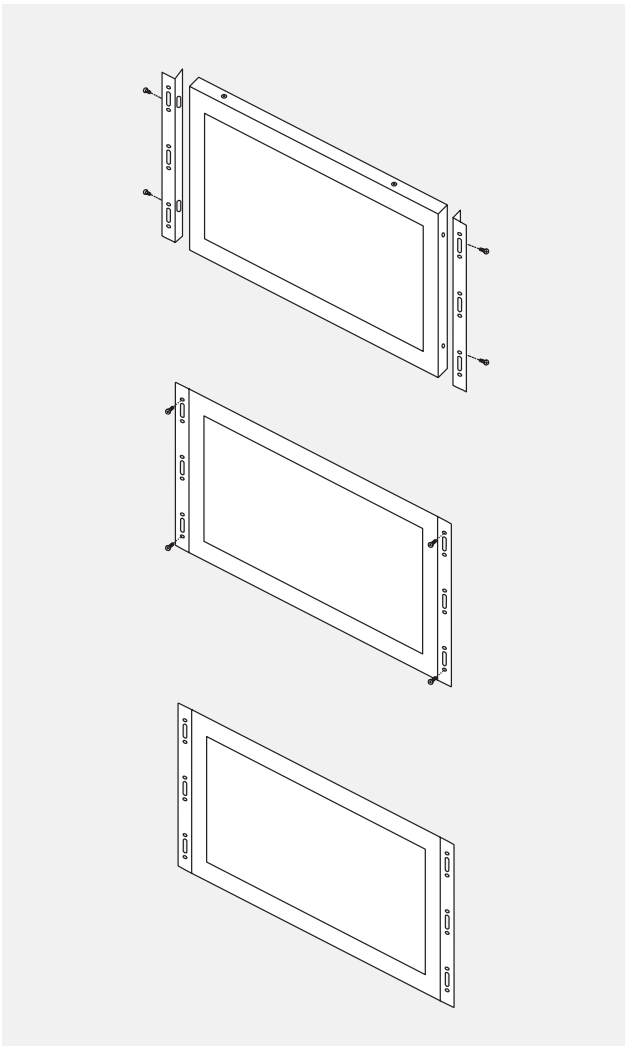

Configuration A | Surface-Fixed

The brackets are first attached to the display enclosure. The assembly is then secured directly to the mounting surface.

- Mounting screws remain visible from the front.
- Overall width increases slightly due to bracket thickness.

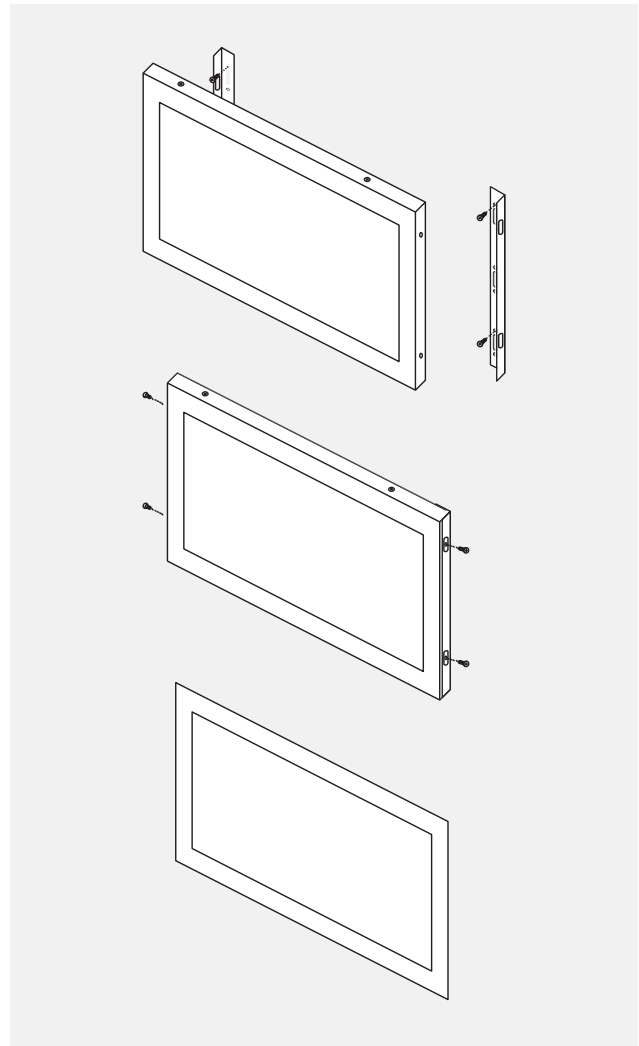

Configuration B | Recessed Installation

The brackets are first secured to the mounting surface. The display is then inserted and secured from the side.

- Front surface remains visually clean.
- Display width increases minimally due to bracket thickness.

3.3.5 Rack Mounting (Optional RMK7 Rack Adapter Plate)

Selected models may be installed in a standard 19-inch equipment rack using the optional RMK7 rack adapter plate. The RMK7 consists of a fixed metal rack plate with integrated 19-inch rack mounting flanges. Multiple hole patterns support various VESA configurations.

The display is secured to the rack plate via the rear VESA interface. This is a fixed mounting solution. Sliding rails or drawer mechanisms are not included.

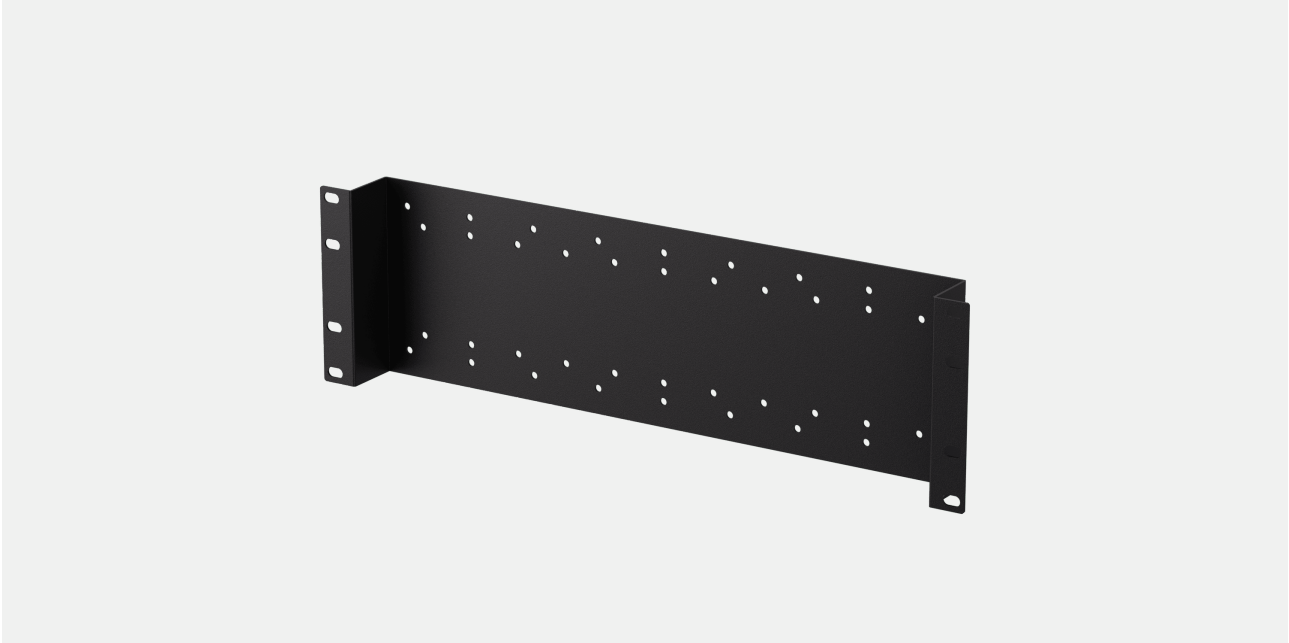

Compatibility

- Maximum horizontal installation width: 19-inch 5:4 display.
- 17-inch widescreen models are compatible.
- Smaller displays may be mounted; unused rack space may remain.
- Portrait configurations may be possible depending on rack design.
- Multiple smaller displays may be installed side-by-side where space permits.

Installation requirements

- The combined weight shall not exceed rack load capacity.
- Adequate ventilation clearance shall be maintained within the rack enclosure.
- Rack fasteners shall match rack rail specifications.

3.3.6 Panel Mounting

Panel mounting is supported on designated touch models equipped with an integrated mounting bezel. This method allows the display to be integrated into a cabinet, console, or control panel from the rear, providing a flush-front finish.



Installation Procedure

1. **Prepare the Panel Cutout:** Create a cutout in the mounting surface. For maximum precision, it is highly recommended to base the cutout dimensions on the 3D Drawing (STP file) available for download on the product detail page for each specific model, under the "Downloads" tab. Regional website addresses are listed in Section 9.4.
2. **Attach the Mounting Brackets:** Attach the supplied L-brackets to the threaded mounting points on the rear side of the display.
3. **Insert the Display:** Place the display into the panel cutout from the front side of the enclosure. The front bezel includes an overhang that rests against the front surface of the panel to properly position the display. A rubber sealing gasket is integrated into the back of the bezel to help create a secure seal between the display and the panel surface.
4. **Install the Mounting Clips:** Slide the panel mounting clamps into the slots on the L-brackets.
5. **Secure the Display:** Tighten the tensioning screws located in the center of each mounting clamp. As the screws are tightened, the screw tips will press against the rear side of the panel, securing the display firmly in place. Tighten the fasteners evenly across all mounting points to ensure proper alignment and uniform pressure around the display perimeter.

NOTICE

Cutout Accuracy and Mechanical Stress

The system integrator is responsible for ensuring the following:

- **STEP File Reference:** Always verify physical dimensions against the latest 3D Drawing (STP file) on the relevant regional Beetratics website before finalizing panel cutouts to account for hardware revisions and tolerances. Regional website addresses are listed in Section 9.4.
- **Integrated Gasket:** The display is equipped with a pre-installed, recessed sealing ring within the metal bezel. Ensure the mounting surface is clean and level to allow this seal to function correctly.
- **Fastener Torque:** Do not overtighten the tensioning screws. Excessive torque may result in bending of the enclosure, mechanical stress on the LCD panel, or permanent hardware damage.
- **Mechanical Alignment:** Ensure the display is centered within the cutout to prevent uneven pressure on the touch sensor or bezel.

3.4 Compass Safe Distance (Maritime Installations)

For maritime installations, the display shall be positioned to prevent magnetic interference with navigation equipment.

The values provided below support component-level evaluation in accordance with maritime standards including DNV-CG-0339 and IEC 60945.



Magnetic Interference

Failure to maintain the minimum safe distance between the display and magnetic navigation equipment may result in compass deviation or malfunction, which could lead to navigation errors and risk to vessel and crew safety. To ensure proper magnetic compass operation, the display must be installed at or beyond the minimum safe distance specified in the table below. The system integrator is responsible for verifying compass performance and ensuring final vessel-level compliance after installation.

Model	Max Value Standard Compass:	Max Value Steering Compass:
27TS7M/U1	1000mm	750mm
24TS7M/U1	1000mm	750mm
22TS7M/U1	1000mm	750mm
19TS7M/U1	1000mm	750mm
19TSV7M/U1	1000mm	750mm
17TSV7M/U1	1000mm	750mm
17TS7M/U1	1000mm	750mm
15TSV7M/U1	1000mm	750mm
15TS7M/U1	1000mm	750mm
13TS7M/U1	1000mm	750mm
12TSV7M/U1	1000mm	750mm
12TS7M/U1	1000mm	750mm
10TS7M/U1	1000mm	750mm
10TSV7M/U1	1000mm	750mm
8TSV7M/U1	1000mm	750mm
7TS7M/U1	650mm	300mm
27HB9M/U1	900mm	700mm
24HB9M/U1	900mm	700mm
22HB9M/U1	900mm	700mm
19HB9M/U1	900mm	700mm
17HB9M/U1	900mm	700mm
15HB9M/U1	900mm	700mm
12HB9M/U1	900mm	700mm
10HB9M/U1	500mm	400mm



Electrical & System Integration

4. Electrical & System Integration

» This chapter defines the technical requirements for electrical power integration, grounding, and signal interfacing of the display component. Electrical integration shall be performed by qualified personnel in accordance with applicable safety standards and local regulations.

4.1 Power Supply Requirements

The display component has been evaluated at component level using approved Beetronics power supplies.



Power Supply Selection

Use only the official Beetronics power supply supplied with the product or the model specified for the applicable region or configuration. Use of unauthorized adapters, modified power supplies, or third-party power sources may result in electric shock, fire, or equipment damage, and may result in operation outside the evaluated compliance configuration.

Sector-Specific Power Configurations

The standard power supply provided with the display is intended for general professional use only. For installations requiring compliance with specific regulatory frameworks, the standard power supply must be replaced with the corresponding Beetronics sector-specific power supply:

Maritime Applications (DNV / IEC 60945): Compliance requires the exclusive use of the PSU1-MAR power supply.



Medical Use Limitation

This display is not a medical device and is not intended for use as a primary medical alarm or safety indicator. Reliance on the audio or visual output of this display for critical patient notification or life-sustaining functions could result in failure to alert, leading to serious injury or death.

Medical Equipment Integration (EN 60601-1): Compliance requires the exclusive use of the PSU1-MED power supply.

4.2 DC Power Integration

The display hardware supports a DC input range of 9 V to 36 V to provide integration flexibility.



Integration into External DC Systems

Direct connection to raw, unregulated, or transient-prone DC power sources (such as vehicle or industrial battery systems) is outside the scope of the evaluated compliance configuration.

Where integration into external DC systems is required, voltage stability, surge protection, transient suppression, filtering, and safety isolation shall be validated at the system level by the integrator.

4.3 Grounding and Isolation

Displays with metal enclosures are equipped with a grounding screw marked with the protective earth symbol



Earthing and Isolation

Failure to implement an appropriate grounding scheme may result in electric shock, fire, or EMC non-compliance.

Determination and implementation of the appropriate grounding method is the responsibility of the system integrator or installer. The final installation shall ensure:

- Proper protective earth connection where required
- Prevention of ground loops
- Compliance with applicable safety and EMC requirements

Proper management of interaction between DC negative and chassis earth in isolated or floating systems

4.4 Signal Connections

To operate correctly, the display must be connected to a compatible video source and, where applicable, audio and touch input.

Video Interfaces

- **HDMI:** transmits digital video and audio.
- **DisplayPort:** transmits digital video and audio.
- **VGA:** transmits analog video only.

Touch Interface

- **Touch Interface**
- **USB-C to USB-C cable:** Depending on the source device, a single cable can transmit video, audio, and touch data (HID).
- **USB-C to USB-A cable:** Transmits touch data only. Video must be connected separately via HDMI, DisplayPort, or VGA.



Audio Integration

Where video-only interfaces are used, audio must be connected separately via the **AUX IN** port. External speakers or headphones may be connected to the **AUX OUT** port where supported.



Audio Signal Routing

The **AUX OUT** port is designed for audio extraction from digital sources (HDMI, DisplayPort, or USB-C). Analog audio received via the **AUX IN** port is intended for playback through the integrated speakers only and is not routed to the **AUX OUT** port.



Signal Integrity and EMC Performance

To maintain signal integrity and EMC performance, do not exceed the following recommended maximum cable lengths:

- **HDMI:** 10 m
- **VGA:** 15 m
- **DisplayPort:** 5 m
- **USB:** 3 m
- **Aux:** 10 m

Signal and power cables shall be strain-relieved and routed to minimize electromagnetic interference and mechanical stress.

4.5 Initial Installation & Connection Overview

This section describes the recommended sequence for first-time power-up and functional verification of the display.

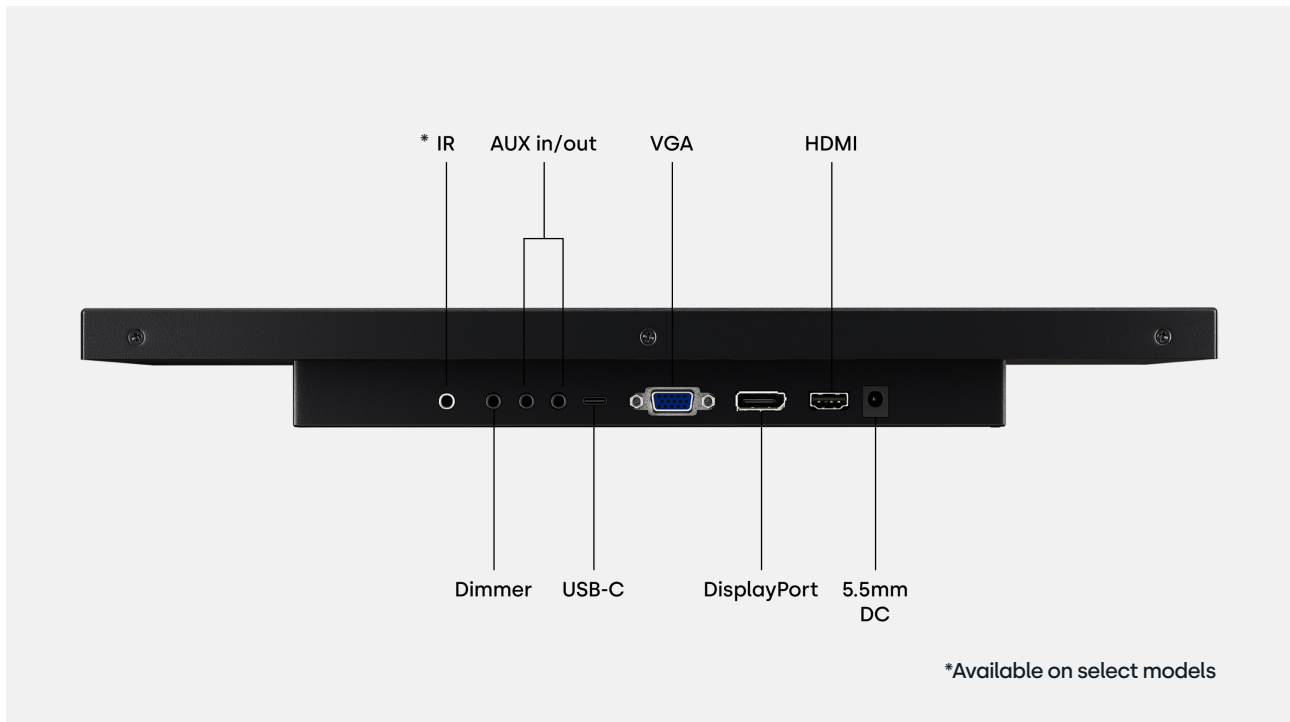

4.6 Foreseeable Misuse and Integration Risks

The display component is designed for professional integration. The following foreseeable integration errors or improper use scenarios may result in malfunction, reduced performance, equipment damage, or loss of compliance at the system level.

Improper integration may lead to unpredictable system behavior, reduced lifespan, EMC non-compliance, or permanent hardware damage. Beetrionics assumes no responsibility for system-level failures resulting from improper integration practices.

NOTICE

System-Level Integration Responsibility

The system integrator is responsible for preventing the following foreseeable misuse scenarios:

- **Unregulated Power:** Direct connection to raw or unregulated DC power systems (e.g., vehicle batteries) without appropriate stabilization, filtering, and transient protection, outside the evaluated DC 9–36 V range.
- **Cable Lengths:** Exceeding recommended maximum signal cable lengths for HDMI (10 m), VGA (15 m), DisplayPort (5 m), USB (3 m), or Aux (10 m).
- **Signal Quality:** Use of low-quality cables or USB-C cables intended only for charging, which lack the data lines required for HID touch communication.
- **Interference:** Routing signal cables parallel to high-current or high-frequency power lines without adequate separation.
- **Thermal Management:** Installation inside sealed enclosures without sufficient ventilation or thermal dissipation, leading to temperatures exceeding the +60 °C (140 °F) operating limit.
- **Moisture:** Powering the unit while condensation is present or operating outside the 10% – 90% non-condensing humidity range.
- **Unauthorized Power Supplies:** Use of non-approved or modified power supplies instead of the specified Beetrionics power adapter or sector-specific PSUs (PSU1-MAR / PSU1-MED) where required for compliance.
- **Mechanical Stress:** Improper integration resulting in mechanical stress caused by incorrect mounting hardware (e.g., VESA 75x75 mm screws that are too long) or excessive fastener torque.



Operation & Control

5. Operation & Control

» This chapter describes normal operation of the display, including control interfaces, menu configuration, and system behavior.













5.1 Remote Control

The display is operated using the supplied infrared remote control. The remote provides access to power control, input selection, OSD navigation, brightness adjustment, and USB playback functions.

For reliable operation, ensure direct alignment with the infrared receiver. On certain narrow bezel models, the receiver is positioned at the rear of the enclosure. Reduced responsiveness is typically caused by misalignment or depleted batteries.

The remote control is required to unlock Key Lock mode and to access advanced system configuration settings. To unlock Key Lock mode, open the OSD menu using the MENU button on the remote control and disable Key Lock under the OSD settings tab.



	Power button	Boot or enter standby state
	Mute button	Silence or restore audio output
1-0	Digit keys (1-0)	Used in menu and for numeric selection
	Return button	Return to previous menu or function
INPUT	Input button	Select the input source channel
	Cursor keys	Navigate up, down, left, and right
OK	OK button	Confirm your selection
EXIT	Exit button	Exit menu or current operation
MENU	Menu button	Open or close the OSD menu
DISP	Disp button	Display current source information
	Volume (+ / -)	Increase or decrease audio volume
	Brightness (+ / -)	Adjust the backlight intensity
SLEEP	Sleep button	Set the automatic sleep timer
	Previous	Skip to the previous file (USB media files)
	Play/Pause	Play or pause playback (USB media files)
	Rewind	Rewind playback (USB media files)
	Next	Skip to the next file (USB media files)
	Stop	Stop playback (USB media files)
	Fast Forward	Fast forward playback (USB media files)

5.2 Physical Control Buttons

The display enclosure includes integrated control buttons for local operation. Button layout varies between metal and plastic enclosure models, but functionality remains consistent.

The enclosure controls allow power operation, input selection, menu access, and parameter adjustment. These controls provide basic configuration capability without requiring the remote control.

If Key Lock is enabled, the enclosure buttons are disabled and configuration must be performed using the remote control.

Metal Touchscreen



- | | | |
|---|---------------|--|
| 1 | ON/OFF | • Power On/Off |
| 2 | — | • Decrease value |
| 3 | + | • Increase value |
| 4 | AUTO | • Select source
• Cycle options
• In-menu selector |
| 5 | MENU | • Open menu
• In-menu back |
| 6 | LED | • Power on: green light
• Standby: red light |

Plastic Touchscreen



- | | | |
|----------|--------------|---|
| 1 | POWER | <ul style="list-style-type: none">• Power On/Off |
| 2 | MENU | <ul style="list-style-type: none">• Open menu• In-menu back |
| 3 | + | <ul style="list-style-type: none">• Right• Increase Value• In-menu- select |
| 4 | - | <ul style="list-style-type: none">• Left• Decrease value |
| 5 | AUTO | <ul style="list-style-type: none">• Select source• Cycle options (up/down)• Menu select |

5.3 OSD Menu

Press the MENU button on the remote control or on the display enclosure to access the On-Screen Display (OSD).

Menu navigation is performed using the cursor keys on the remote control or the directional buttons on the enclosure. Confirm selections using the OK (ENTER) button on the remote or the corresponding selection button on the display.

The OSD is organized into five primary categories, each represented by a separate tab:

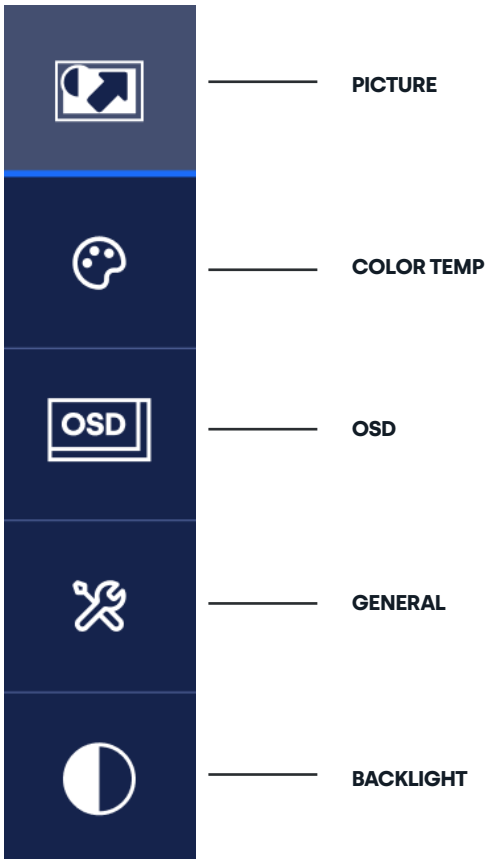

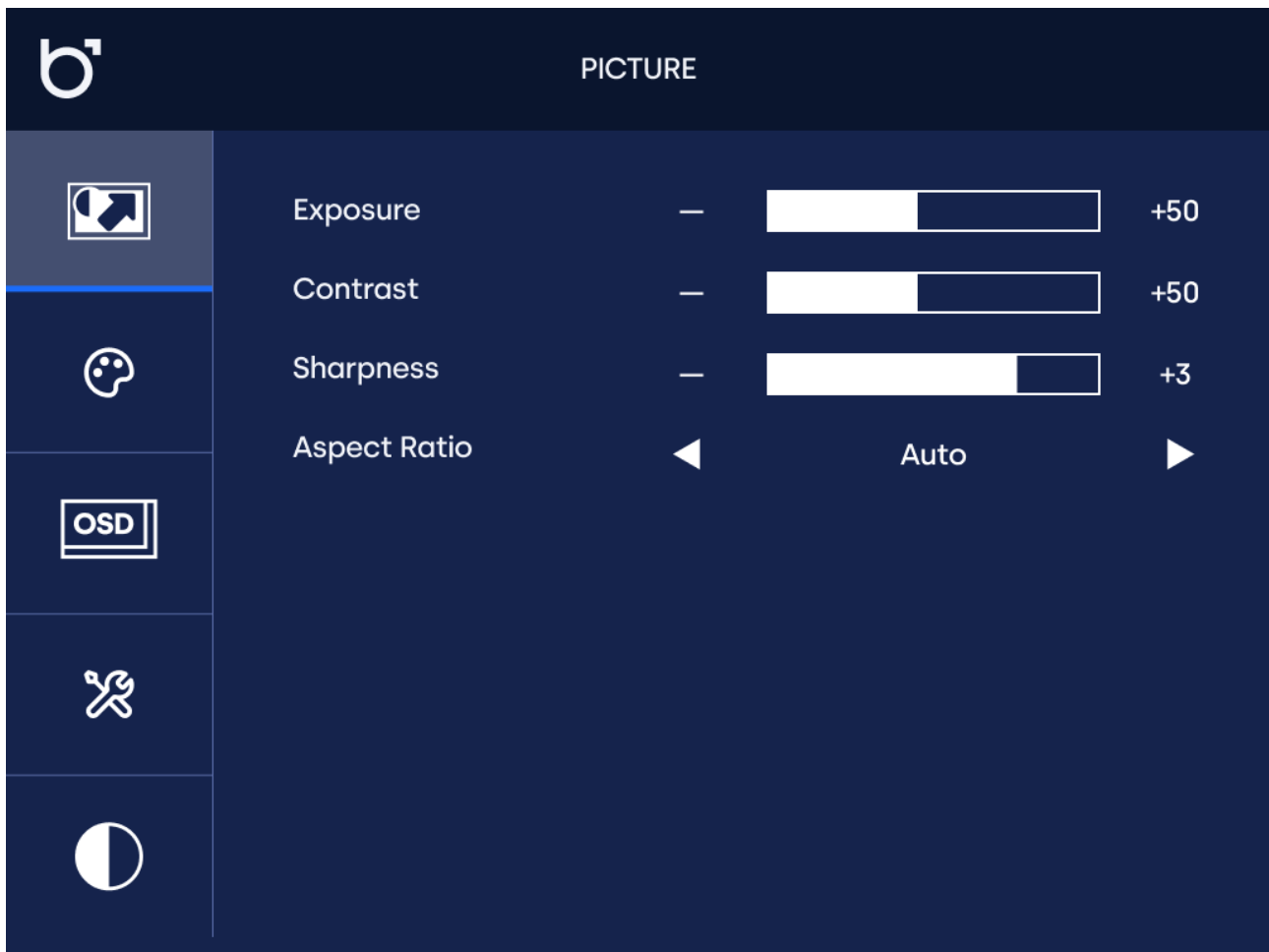

5.3.1 Picture

Exposure

Adjust the image brightness level. Increasing this setting makes the image appear lighter, while decreasing it makes the image darker. This setting does not affect the backlight intensity.

Contrast

Adjust the difference between the lightest and darkest areas of the image.

Sharpness

Adjust the edge definition of the image for a sharper or softer appearance.

Aspect Ratio

Adjust the display format to match the input source. The default setting is Auto. Available options depend on the active input source and require a connected signal.

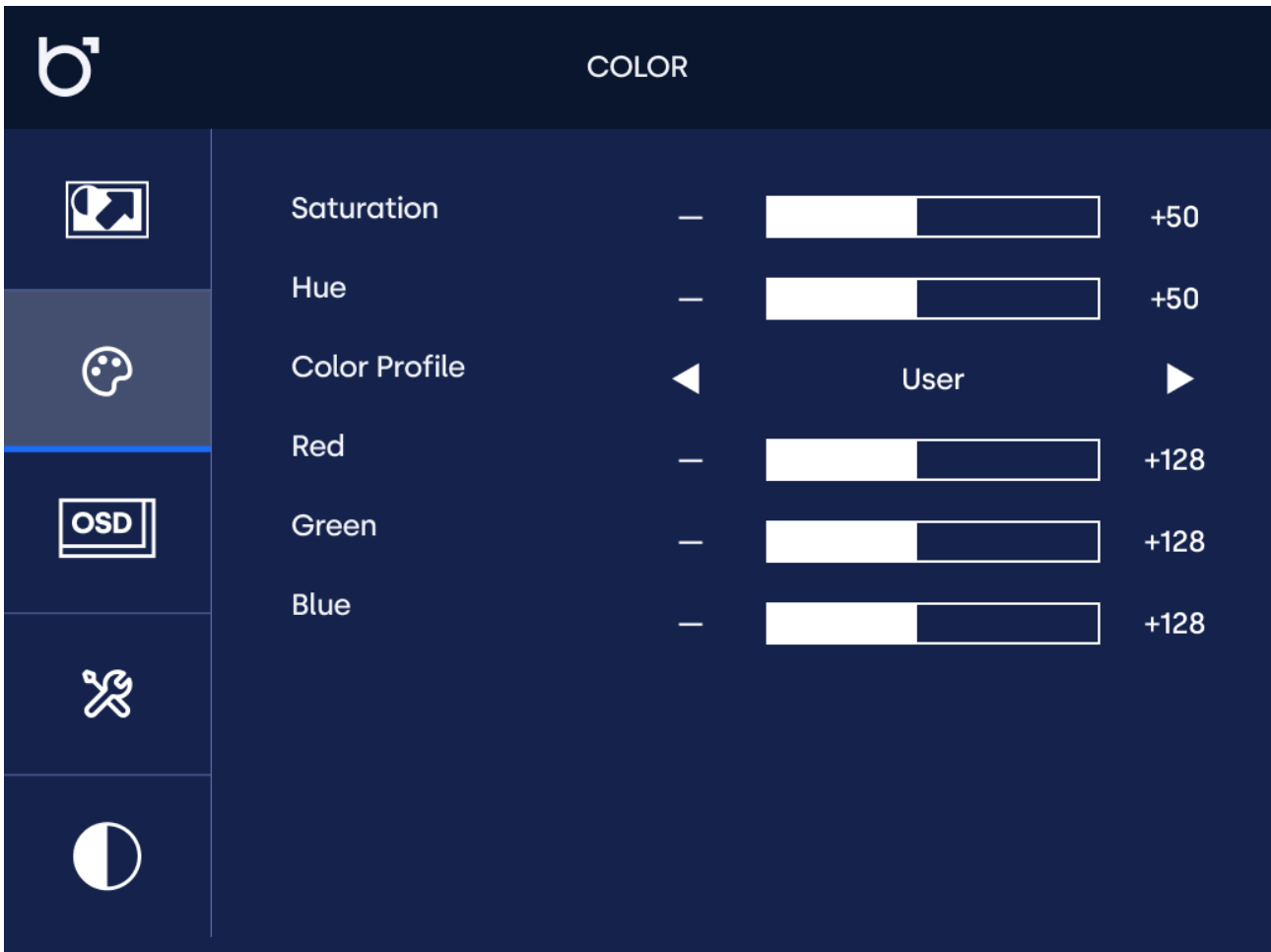

5.3.2 Color

Saturation

Adjust the overall color saturation of the image. This parameter is only adjustable when the color mode is set to "User".

Hue

Adjust the color balance between red and green tones. This parameter is only adjustable when the color mode is set to "User".

Color Profile

Select a predefined color tone. Select "User" to manually adjust color settings. Available options depend on the active input source and require a connected signal.

Red

Adjust the intensity of the red color component. This parameter is only adjustable when the color mode is set to "User".

Green

Adjust the intensity of the green color component. This parameter is only adjustable when the color mode is set to "User".

Blue

Adjust the intensity of the blue color component. This parameter is only adjustable when the color mode is set to "User".

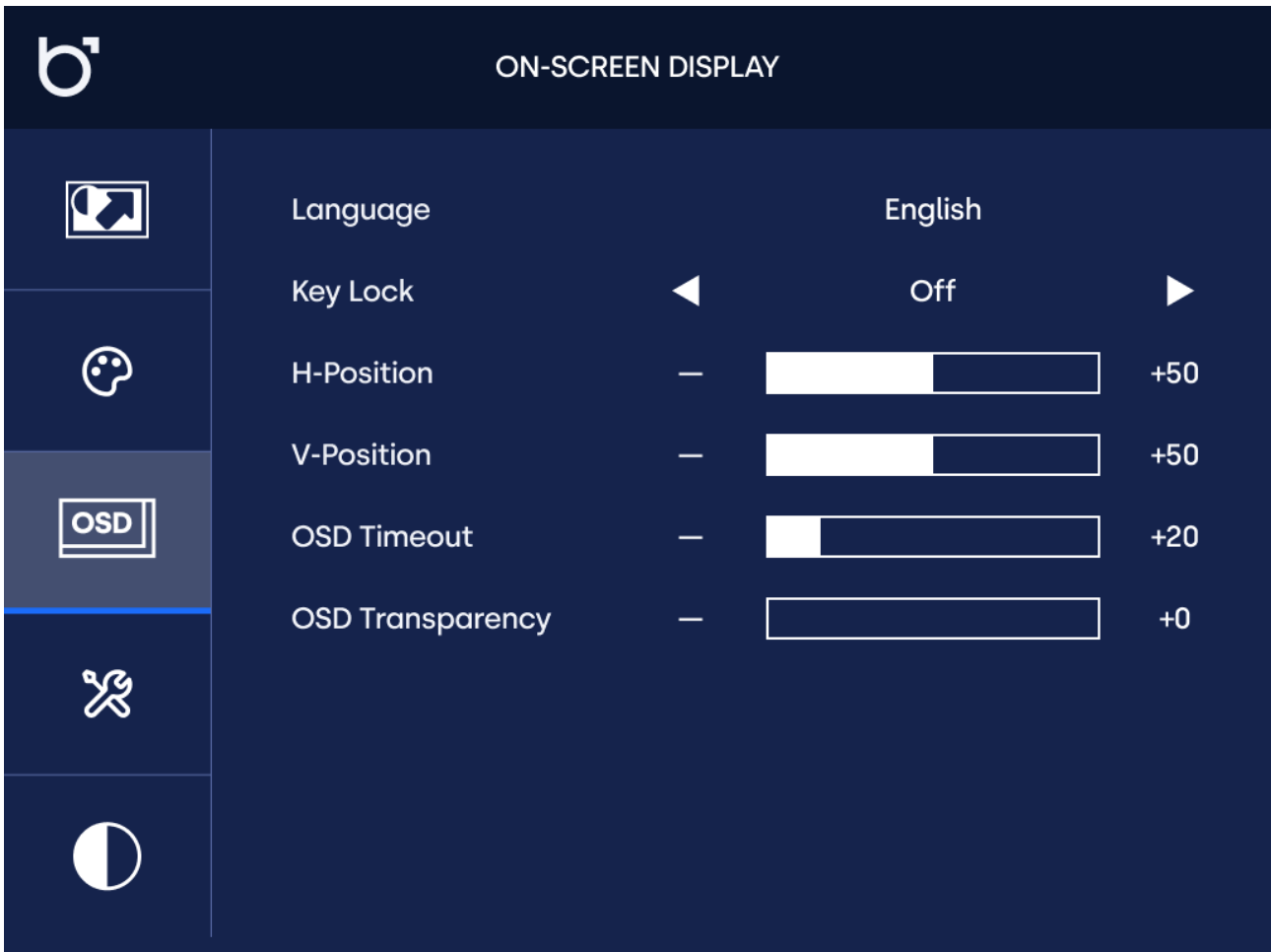

5.3.3 On-Screen Display

Language

Displays the language of the on-screen display (OSD).

Key Lock

Disable the physical control buttons on the display to prevent unauthorized adjustments.

H-Position

Adjust the horizontal position of the OSD menu.

V-Position

Adjust the vertical position of the OSD menu.

OSD Timeout

Adjust the duration the OSD menu remains visible before automatically closing.

OSD Transparency

Adjust the transparency level of the OSD menu.

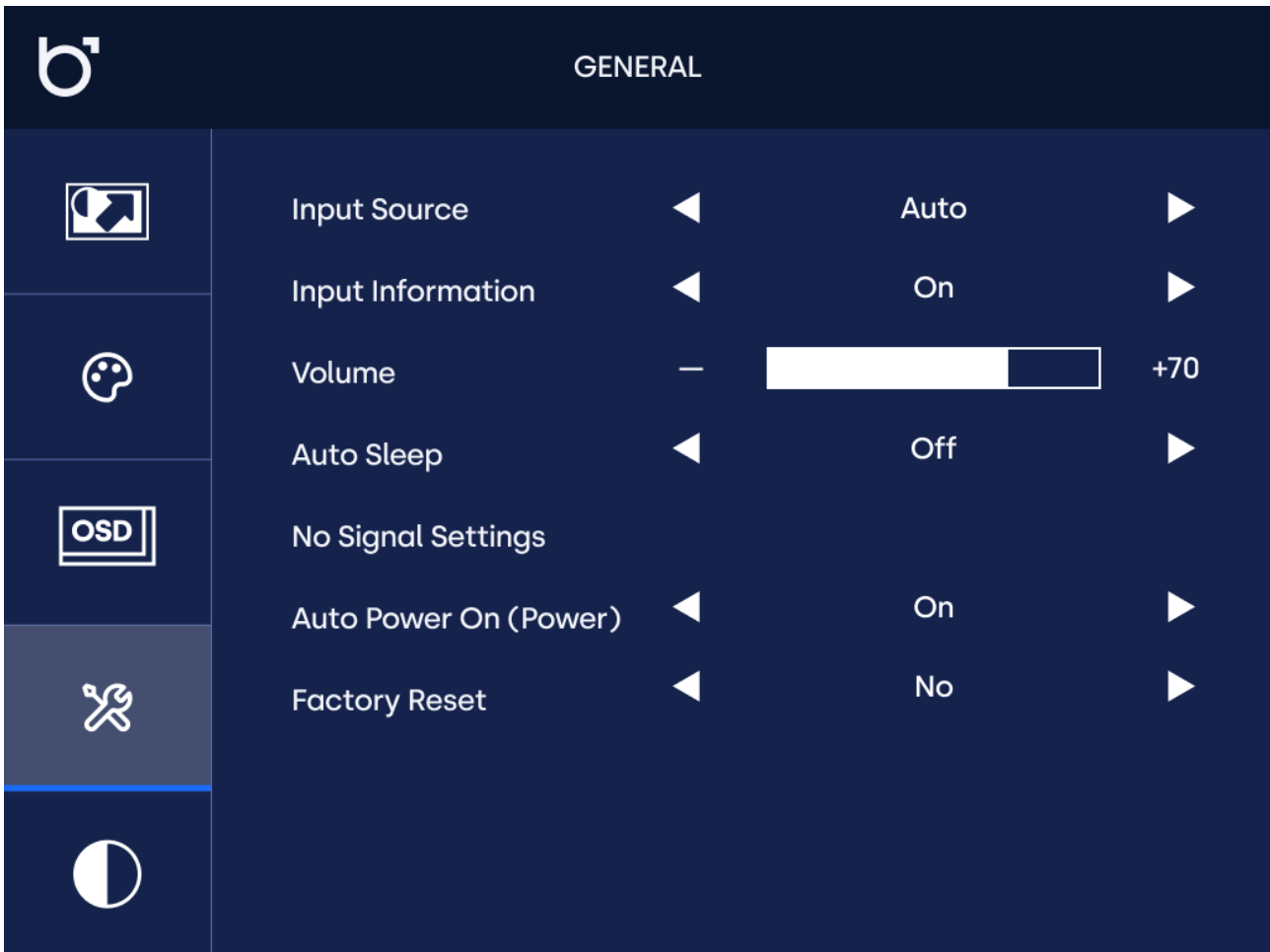

5.3.4 General

Input Source

Select the input source channel. When set to Auto, the display automatically detects the active input signal.

Input Information

Enable or disable the display of input source information on screen.

Volume

Adjust the audio output level.

Auto Sleep

Set the display to automatically enter standby mode when no user interaction is detected.

No Signal Settings

Configure the display behavior when no active input signal is detected, including timing, power mode, and on-screen message.

- **No Signal Timer**
Define the duration the display remains on without an active input signal before applying the selected no signal mode.
- **No Signal Mode**
Select the behavior when no signal is detected. Available options include Standby or Shutdown.
- **No Signal Message**
Enable or disable the on-screen "No Signal" message when no input signal is detected. When disabled, a black screen is shown.

Auto Power On (Power)

Configure the display to automatically power on when DC power is applied.

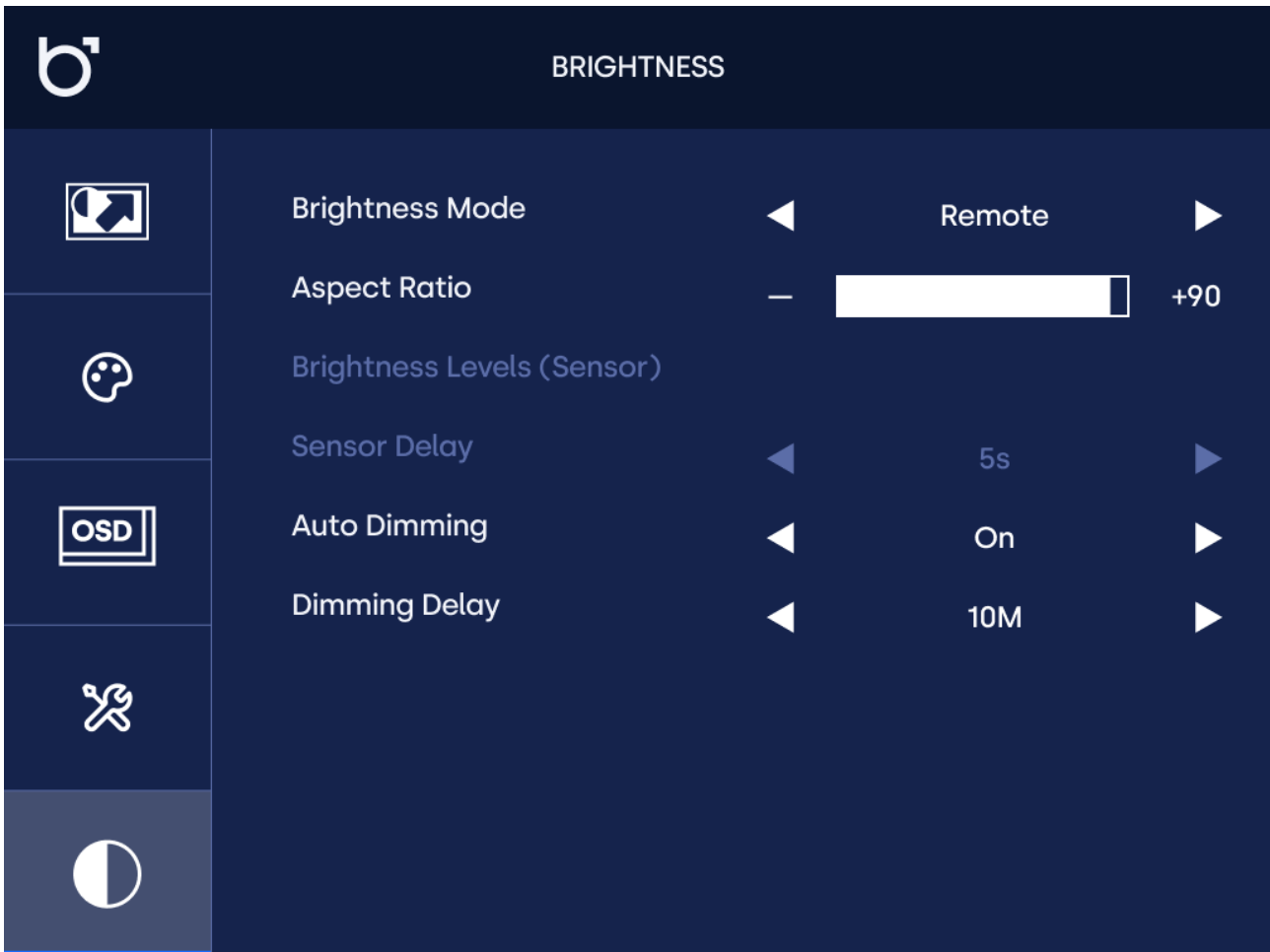

5.3.5 Brightness

Brightness Mode

Select how the backlight brightness is controlled. Available options include:

- **Remote:** Brightness is adjusted manually using the remote control (included as standard) or the physical buttons on the display enclosure.
- **Dimmer:** Brightness is controlled by an external analog dimmer signal connected to the Dimmer input on the display. This option requires the optional DMK7 or DMK8 dimmer accessory.
- **Sensor:** Brightness is adjusted automatically based on ambient light conditions detected by the integrated light sensor. This option is available on High-Brightness Touchscreen Series models only.

Brightness

Manually adjust the brightness intensity from 0–100. This setting is only available when Brightness Mode is set to Remote.

Brightness Levels

Define four brightness levels used by the ambient light sensor: Min, Low, High, and Max. Each level can be adjusted from 0–100. The display automatically switches between these levels based on ambient light conditions. This setting is only available when Brightness Mode is set to Sensor.

Sensor Delay

Define the response delay of the ambient light sensor before adjusting the backlight level. This setting is only available when Brightness Mode is set to Sensor.

Auto Dimming

Enable or disable automatic dimming of the screen after a period of inactivity.

Dimming Delay

Define the duration of inactivity before the screen dimming function is applied.

5.4 Touch Functionality & OS Compatibility

Beetronics touchscreens utilize Projected Capacitive (PCAP) technology with 10-point multi-touch, communicated via HID (Human Interface Device) over USB.

- **Plug & Play:** Most modern operating systems (Windows, Linux, ChromeOS, Android) recognize the touchscreen automatically. No manual driver installation is required when the display is used in its native resolution.
- **macOS Support:** Requires the UPDD (Universal Pointing Device Driver). This driver must be downloaded from the Beetronics Helpcenter on the regional website. Regional website addresses are listed in Section 9.4.
- **Multi-Monitor Mapping:** In setups with multiple displays, the operating system may initially assign touch input to the primary screen. Use the OS-native "Tablet PC Settings" (Windows) or "UPDD Console" (macOS) to map the touch interface to the correct display.
- **Calibration:** Calibration is typically handled automatically. If touch alignment is inaccurate (e.g., when using non-native resolutions), perform a calibration through the operating system settings.
- **Pre-OS Environments:** Touch functionality is generally not available within the BIOS or during the initial OS boot sequence, as these environments lack the necessary HID driver support.

NOTICE

USB Power & Data Requirements

The touchscreen controller is powered via the USB connection. To ensure stable operation:

- Use the supplied high-quality Beetronics USB cables.
- Avoid unpowered USB hubs or passive extenders.
- For cable runs exceeding 3 meters (10 feet), an active (powered) USB extender is required to prevent signal dropouts.



Maintenance, Cleaning & Burn-in Prevention

6. Maintenance, Cleaning & Burn-in Prevention

» This chapter defines the required maintenance procedures, handling precautions, and operating practices to ensure continued reliability and visual performance of the display component.

6.1 Maintenance and Handling Guidelines

To maintain optimal performance and prevent damage, the following handling precautions shall be observed.

NOTICE

Touch Surface Variations

All displays in this series feature an IK08-rated glass front. Depending on the specific model, the glass surface may feature an integrated anti-glare haze treatment or a high-gloss finish. To confirm the glass surface type for a specific model, refer to the product specifications available on the regional Beetrionics website. Regional website addresses are listed in Section 9.4.

- Avoid hitting the surface with heavy or sharp metal objects to prevent structural damage.
- Do not use abrasive cleaning pads, steel wool, or polishing compounds. On models with an integrated haze treatment, abrasive materials can permanently alter the surface texture and visual uniformity.

6.2 Cleaning Instructions

Always disconnect the power supply before performing any cleaning activities. Failure to do so may result in electric shock or equipment damage.

WARNING

Disconnect Power Before Cleaning

1. **Disconnect Power:** Disconnect the power supply before proceeding.
2. **Cloth Selection:** Use a clean, soft microfiber cloth. The glass surface (both glossy and haze-treated) can be wiped firmly to remove stubborn spots.
3. **Moistening:** If necessary, lightly dampen the cloth with water or a professional glass cleaner. Do not spray liquid directly onto the glass surface to prevent moisture from seeping into the recessed sealing ring or enclosure edges.
4. **Drying:** Ensure all surfaces are completely dry before reconnecting power.

NOTICE

Prohibited Cleaning Agents

While the glass is chemically resistant, avoid the following to protect the enclosure and internal electronics:

- Antiseptic solutions or bleach.
- Thinner, benzene, or wax.
- Abrasive cleaners, ammonia, or acetone.

6.3 Image Retention (Burn-In) Prevention

Prolonged display of static or unchanging images may cause image retention, also referred to as burn-in, after-imaging, or ghost imaging. This is a known characteristic of LCD panel technology.

WARNING

Permanent Image Damage

Failure to activate a moving screen saver or periodic screen refresh when displaying static content may result in severe image retention.

To reduce the risk of permanent image damage:

- Always activate a moving screen saver when the display is unattended
- Use periodic screen refresh or content rotation for static visual content

In severe cases, image retention effects may become permanent and cannot be corrected.

6.4 Environmental Operating Limits

To maintain performance and maximize product lifespan, the display shall be stored and operated within the following environmental limits.

Standard Touchscreens

- Operating Temperature: -10 °C to +60 °C (14 °F to +140 °F)
- Storage Temperature: -20 °C to +70 °C (-4 °F to +158 °F)
- Operating Humidity: 10 % to 90 % non-condensing

High-Brightness Touchscreens

- Operating Temperature: -20 °C to +70 °C (-4 °F to 158 °F)
- Storage Temperature: -30 °C to +80 °C (-22 °F to 176 °F)
- Operating Humidity: 10 % to 90 % non-condensing



Troubleshooting & FAQ

7. Troubleshooting & FAQ

» This chapter provides troubleshooting guidance for common technical issues and answers to frequently asked questions related to the operation and integration of the display component. Only issues relevant to the display itself are included. Troubleshooting is intended to assist qualified integrators and installers. If an issue cannot be resolved using the guidance below, please contact your local Beetrionics support via the regional website. Regional website addresses and contact details are listed in Section 9.4.

7.1 Troubleshooting

Power & Startup

Issue	Possible Cause	Corrective Action
Display does not power on	<ol style="list-style-type: none">1. Power supply not connected or defective2. Incorrect DC voltage or polarity	<ol style="list-style-type: none">1. Verify approved power supply connection and test with known functional unit.2. Verify input voltage and polarity (9–36 V).
Power LED on, no image	<ol style="list-style-type: none">1. No active video signal2. Incorrect input selected	<ol style="list-style-type: none">1. Verify source device is powered and transmitting signal.2. Select the correct input using the monitor buttons or remote control.

Video Signal & Image Integrity

Issue	Possible Cause	Corrective Action
"No Signal" message	<ol style="list-style-type: none">1. Source not transmitting2. Unsupported timing3. USB-C Alt Mode not supported	<ol style="list-style-type: none">1. Verify source output.2. Set source to supported native resolution and refresh rate.3. Verify that the source USB-C port supports DisplayPort Alt Mode.
Image blurry or soft	<ol style="list-style-type: none">1. Resolution mismatch2. Excessive cable length	<ol style="list-style-type: none">1. Configure source to native resolution.2. Do not exceed recommended maximum cable lengths (HDMI 10 m / 33 ft, DP 5 m / 16 ft, VGA 15 m / 49 ft).
Image flickers or is unstable	<ol style="list-style-type: none">1. Electrical interference	<ol style="list-style-type: none">1. Separate signal and power cables; eliminate nearby interference sources.

Touch Functionality

Issue	Possible Cause	Corrective Action
Touch does not respond	<ol style="list-style-type: none"> 1. Incorrect USB connection 2. Use of adapters or hubs 3. Charging-only cable used 4. HID device not recognized 5. Missing macOS driver 	<ol style="list-style-type: none"> 1. Ensure the USB touch cable is connected to a data-enabled port. 2. Avoid USB adapters, unpowered hubs, or converters. Connect directly to the source device. 3. Use the supplied Beetrionics cables; third-party charging cables often lack data lines. 4. Verify HID-compliance in OS Device Manager; restart both source and display. 5. Download and install the UPDD driver from the official Beetrionics Helpcenter.
Touch is inaccurate or offset	<ol style="list-style-type: none"> 1. Non-native resolution 2. Missing calibration 	<ol style="list-style-type: none"> 1. Set source to native resolution; scaling artifacts can displace touch mapping. 2. Run the OS-native calibration tool (e.g., Windows Tablet PC Settings).
Ghost touches (Intermittent input)	<ol style="list-style-type: none"> 1. Surface contamination 2. Electromagnetic interference 	<ol style="list-style-type: none"> 1. Clean the glass and the inner edges of the bezel from dust or moisture. 2. Ensure proper grounding and isolate USB cables from high-power lines.

OSD & Control

Issue	Possible Cause	Corrective Action
OSD menu is locked	<ol style="list-style-type: none"> 1. Key Lock enabled 	<ol style="list-style-type: none"> 1. To unlock Key Lock mode, open the OSD menu using the MENU button on the remote control and disable Key Lock under the OSD settings tab.
Remote not responding	<ol style="list-style-type: none"> 1. Battery depleted or misalignment 	<ol style="list-style-type: none"> 1. Replace batteries and ensure line-of-sight with the IR receiver.

7.2 Frequently Asked Questions (FAQ)

Where can I download touchscreen drivers?

Beetronics touchscreens are HID-compliant and operate via Plug & Play on most systems. Drivers (specifically the UPDD for macOS) and detailed calibration guides are available for download on the Beetronics Helpcenter on the regional website. For contact details and regional website addresses, refer to Section 9.4.

Why does the touch input register on the wrong screen?

In multi-monitor setups, the operating system may not automatically assign the touch layer to the correct display. Use the OS "Tablet PC Settings" (Windows) or "UPDD Console" (macOS) to manually map the touch input to the Beetronics display.

Why is it recommended to avoid adapters and extenders?

Touch data (HID) is highly sensitive to signal timing and voltage drops. Adapters, video-to-USB converters, and unpowered hubs often cause handshake failures. The maximum recommended length for passive USB cables is 3 meters (10 feet). For longer distances, an active (powered) USB extender is required.

How can panel defects be distinguished from signal-related artifacts?

Open the On-Screen Display (OSD) menu. If an artifact (such as a line or spot) is visible within the OSD interface, the issue is internal to the display. If the artifact is not visible in the OSD, it originates from the external signal path, cable, or source device.

What is the Beetronics policy on dead pixels?

All Beetronics displays adhere to the ISO 9241-307 Class II standard. This industry standard defines acceptable limits for pixel defects (bright, dark, or sub-pixel) based on resolution. Minor pixel anomalies within these limits are a characteristic of LCD technology and do not constitute a defect.

Can the touchscreen be used with gloves?

Yes, the projected capacitive (PCAP) sensor works with thin surgical, cotton, or specialized industrial gloves. If your application requires thick or heavy-duty gloves, the touch controller sensitivity can be adjusted. Please contact the Beetronics technical department for support regarding custom sensitivity profiles.

Why does the display show "No Signal" via USB-C?

Not all USB-C ports support video output. Ensure the source port supports DisplayPort Alt Mode. If the source only supports data, use the USB-C to USB-A cable for touch and a separate HDMI or DisplayPort cable for video.

Does the display turn on automatically when power is applied?

Yes. All models are configured to power on automatically upon receiving DC power. This "Auto-On" behavior can be adjusted or disabled within the OSD menu under the general settings tab.

Why is the image stretched or distorted?

This is typically caused by an incorrect aspect ratio setting. Ensure the source device is set to the display's native aspect ratio (e.g., 16:9 or 4:3). You can also adjust the "Aspect Ratio" or "Image Scaling" settings within the OSD menu.

Can the display be used in both landscape and portrait orientation?

Yes. The display hardware supports both orientations. Note that the display does not feature an internal gravity sensor; the image rotation must be configured within the operating system or graphics driver settings of the source device.



Regulatory Notices

8. Regulatory Notices

» This chapter summarizes the regulatory framework and compliance scope applicable to the display component. It provides an overview of component-level regulatory evaluations. For complete and legally binding regulatory declarations, refer to Appendix A | Public Compliance Statement.

8.1 FCC Compliance (United States)

This device complies with Part 15 of the FCC Rules. Operation is subject to the following two conditions: (1) This device may not cause harmful interference, and (2) this device must accept any interference received, including interference that may cause undesired operation.

This equipment has been tested and found to comply with the limits for a Class B digital device, pursuant to Part 15 of the FCC Rules. These limits are designed to provide reasonable protection against harmful interference in a residential installation. This equipment generates, uses and can radiate radio frequency energy and, if not installed and used in accordance with the manufacturer instructions, may cause harmful interference to radio communications.

However, there is no guarantee that interference will not occur in a particular installation. If this equipment does cause harmful interference to radio or television reception, which can be determined by turning the equipment off and on, the user is encouraged to try to correct the interference by one or more of the following measures:

- Reorient or relocate the receiving antenna.
- Increase the separation between the equipment and receiver.
- Connect the equipment into an outlet on a circuit different from that to which the receiver is connected.
- Consult the dealer or an experienced radio/TV technician for help.

NOTICE

Unauthorized Modifications

Changes or modifications not expressly approved by Beetrionics could void the user's authority to operate the equipment and invalidate the evaluated compliance configuration.

8.2 ISED Compliance (Canada)

This Class B digital apparatus complies with Canadian ICES-003. Cet appareil numérique de la classe B est conforme à la norme NMB-003 du Canada.

Operation is subject to the following two conditions:

1. This device may not cause interference, and
2. This device must accept any interference, including interference that may cause undesired operation of the device.

L'exploitation est autorisée aux deux conditions suivantes :

1. L'appareil ne doit pas produire de brouillage;
2. L'appareil doit accepter tout brouillage radioélectrique subi, même si le brouillage est susceptible d'en compromettre le fonctionnement.

8.3 Regional Compliance Scope

The display component is evaluated at component level against applicable regional regulatory frameworks where relevant. Regulatory compliance applies only to the product configuration as delivered and documented.

Sector-specific certifications or approvals, including maritime, railway, automotive, or medical standards, are configuration-dependent and may apply only to specific models, hardware revisions, and approved Beetrionics power supplies. Compliance is not universal across the Touchscreen Series and may depend on the exact SKU, hardware revision, power supply, and installation configuration.

Compliance is maintained only when the display is used with approved Beetrionics power supplies, installed in accordance with this manual, and not modified from the evaluated configuration.

For the precise certification status of a specific model and configuration, refer to Appendix A | Public Compliance Statement. Use of the display outside the evaluated configuration falls outside the documented compliance scope.

All applicable regulatory conformity markings are shown on the product label in accordance with the specific model, configuration, and intended market.

8.4 System-Level Regulatory Responsibility

The display is supplied as an unintegrated component. Regulatory approval, certification, and conformity of the final integrated system remain the responsibility of the system integrator, OEM, or end manufacturer.

This includes, but is not limited to:

- Final EMC testing of the complete system
- Electrical safety certification of the assembled installation
- Environmental and sector-specific declarations
- Verification of compliance within the intended operational environment

Use of the display outside the evaluated component configuration falls outside the scope of Beetrionics' component-level assessments.

8.5 Regulatory Contact Information

For regulatory documentation and component-level compliance inquiries, contact the appropriate Beetrionics entity:

European Union & Global
Beetrionics B.V.
Amsterdam, The Netherlands

United States & Canada
Beetrionics Inc.
Claymont, Delaware

For contact details including phone numbers, email addresses, and regional websites, refer to Section 9.4.



Warranty & Contact Information

9. Warranty & Contact Information

» This chapter defines the limited warranty coverage, liability framework, and official contact channels applicable to the display component. All sales are subject to the applicable Beetrionics General Terms and Conditions.

9.1 Limited Warranty

Warranty coverage is provided by the contracting seller entity identified on the purchase invoice and is governed by the applicable Beetrionics Terms and Conditions referenced at the time of purchase.

Unless otherwise specified in the applicable Terms and Conditions, display components are covered for a period of two (2) years from the original date of purchase as evidenced by the purchase invoice.

- **Warranty Coverage:** The limited warranty applies to defects in materials and workmanship under normal and recommended operating conditions as defined in this manual and subject to the applicable Terms and Conditions.
- **Remedy:** In the event of a valid warranty claim, the contracting seller entity will, at its discretion and in accordance with the applicable Terms and Conditions, repair the defective unit or replace it with a functionally equivalent product. Warranty service may require proof of purchase.

9.2 Warranty Exclusions

The limited warranty does not apply to defects or damage resulting from causes outside the intended use and evaluated configuration of the product. Exclusions include, but are not limited to:

- **Unauthorized Modifications:** Any repair, disassembly, or modification performed by an unauthorized person or third party.
- **Improper Integration:** Damage caused by incorrect installation, including mechanical stress on the touch sensor or bezel caused by excessive fastener torque (e.g., overtightening panel-mount screws).
- **Environmental Limits:** Use outside the environmental limits defined in Section 6.4, including exposure to moisture or corrosive environments.
- **Burn-in (Image Retention):** Permanent image damage caused by the prolonged display of static content.
- **Traceability:** Removal, alteration, or defacement of the product serial number.

9.3 Limitation of Liability

Limitation of liability, exclusions, remedies, and any applicable liability caps are governed exclusively by the applicable Beetrionics Terms and Conditions referenced at the time of purchase.

The applicable Terms and Conditions are those of the contracting seller entity identified on the purchase invoice and may vary by jurisdiction. Beetrionics shall not be responsible for the performance, safety, or regulatory compliance of any system into which the display component is integrated, except as expressly provided in the applicable Terms and Conditions.

9.4 Service and Support Contacts

For technical support, warranty claims, or regulatory inquiries, contact the appropriate Beetrionics entity for your region via the official contact channels listed on the website where the product was purchased.

Offices		
Austria	0720-115-767	www.beetrionics.at
Belgium	03-808-16-03	www.beetrionics.be
Denmark	89-88-42-29	www.beetrionics.dk
France	01-79-97-48-02	www.beetrionics.fr
Germany	02113-878-95-62	www.beetrionics.de
Ireland	01-903-6425	www.beetrionics.ie
Italy	011-1962-1372	www.beetrionics.it
Netherlands	020-700-83-66	www.beetrionics.nl
Norway	21-63-00-02	www.beetrionics.no
Poland	22-397-04-43	www.beetrionics.pl
Spain	911-981-024	www.beetrionics.es
Sweden	0844-680-783	www.beetrionics.se
Switzerland	043-508-07-72	www.beetrionics.ch
U.K.	020-3608-7495	www.beetrionics.co.uk
US	323-433-1644	www.beetrionics.com
CA	647-557-7931	www.beetrionics.ca
Safety & Compliance	+31-20-244-63-65	safety@beetrionics.com

10

Appendix

Appendix A: Public Compliance Statement

Beetronics
Public Compliance Statement

Version: 1.5

Last updated: January 2026

Manufacturer & Regulatory Contact Information

Manufacturer (EU & Global)

Beetronics B.V.
Bloemstraat 28, 1016 LC Amsterdam, The Netherlands

US Responsible Party (FCC)

Beetronics Inc.
2093 Philadelphia Pike #4945, Claymont, DE 19703, United States

Contact:

info@beetronics.com | www.beetronics.com

Product Applicability

This statement applies to the following Beetronics display product families, supplied as **unintegrated professional display components**:

Monitor Series: 7HD7M to 32HD7M

Touchscreen Series: 7TS7M/U1 to 32TS7M/U1

High Brightness Series: 10HB9M/U1 to 27HB9M/U1

1. Scope and Responsibility

This document applies exclusively to Beetronics products supplied at component level. It does not represent approval, certification, or suitability of any complete system or end-use application (including vehicles, vessels, medical devices, or other regulated systems). Final system compliance, risk analysis, and regulatory approval remain the responsibility of the system integrator, OEM, or end manufacturer, in line with standard industry practice for modular components.

Unless formally agreed in writing, Beetronics products are not intended for use as life-supporting or safety-critical components. This statement does not constitute system-level certification, end-use approval, or a warranty of fitness for a specific application. It is intended to support and facilitate professional system integration and system-level certification activities.

2. General Regulatory and Safety Framework

Representative samples of applicable product families have been evaluated against, or designed with the objective of meeting, the following regulatory frameworks, where applicable:

European Union	CE Marking <ul style="list-style-type: none">• Electromagnetic Compatibility Directive 2014/30/EU• Low Voltage Directive 2014/35/EU• RoHS Directive 2015/863/EU
United Kingdom	UKCA Marking <ul style="list-style-type: none">• Electromagnetic Compatibility Regulations 2016• Electrical Equipment (Safety) Regulations 2016• Restriction of the Use of Certain Hazardous Substances Regulations 2012
United States	FCC <ul style="list-style-type: none">• 47 CFR Part 15• 47 CFR Part 18
Canada	ISED <ul style="list-style-type: none">• RCM• ICES-003
Australia / New Zealand	ANSI C63.4 <ul style="list-style-type: none">• Applicable AS/NZS CISPR EMC standards and recognised electrical safety requirements

3. Environmental and Substance Considerations

Based on current assessments, supplier declarations, and available documentation at the time of manufacture and supply, representative product samples have been evaluated with respect to:

RoHS	EU Directive 2015/863/EU
REACH	Regulation (EC) No. 1907/2006, SVHC status-based
WEEE	Covered under applicable registration and take-back obligations where required. This product must not be disposed of with unsorted municipal waste. As professional electronic equipment, it must be collected and processed separately in accordance with applicable waste electrical and electronic equipment (WEEE) regulations. For information on approved collection, return, or take-back options, please contact your local Beetronics office.
California Proposition 65	Evaluated against applicable disclosure requirements.
Conflict Minerals (3TG)	Addressed through supplier-level declarations where applicable.

REACH obligations are dynamic; material status is assessed based on the regulatory framework in force at the time of manufacture and supply.

4. Conditions and Evaluation Methodology

The following section provides additional detail on the conditions and methodology under which the above compliance framework applies.

4.1 Delivered Configuration and Modifications

Compliance evaluations described in this statement apply to products in their delivered configuration, as defined in applicable test reports, certifications, and technical documentation. This statement does not extend to:

- mechanical or electrical modification of the product,
- opening or alteration of the housing,
- firmware or software modification,
- use of non-Beetronics power supplies, except where explicitly specified (e.g. PSU1-MAR, PSU1-MED),
- integration with third-party equipment outside evaluated configurations.

For projects requiring custom integration or modification, Beetronics can provide technical information and pre-evaluation guidance upon request. Any modified configuration remains subject to separate compliance assessment.

4.2 Environmental and Installation Factor

Environmental conditions, installation methods, enclosure design, cabling, grounding, and system-level certifications are outside the scope of this statement and are addressed at system level by the integrator.

4.3 Representative / Family Testing

Compliance assessments are conducted on representative models within each product family. Test results are applied to equivalent models sharing identical electrical, mechanical, thermal, and EMC-relevant design characteristics. This methodology aligns with established industry practice for scalable and modular display platforms.

5. How to Use This Statement

This Public Compliance Statement is intended to support:

- engineering evaluation,
- procurement and sourcing decisions,
- component-level compliance assessment.

It does not replace system-level certification, regulatory approval, or risk analysis required for the final application.

6. Statement of Conformance

Beetronics states that representative samples of the products covered by this document have been designed, manufactured, and evaluated at component level in alignment with the referenced regulatory frameworks and standards, subject to the defined scope, methodology, conditions, and limitations.

7. Integration and Documentation Support

Beetronics maintains detailed test reports, evaluations, and supporting compliance documentation for the product families listed in this statement. Where required for engineering review, audits, or system-level certification activities, relevant documentation can be made available upon request. Provision of such documentation does not alter the scope or responsibility allocation defined in this statement.

Important Information

This document is provided for informational purposes to support professional evaluation and procurement. It does not constitute a warranty, guarantee, or certification of end-use suitability. All sales are subject to the Beetronics General Terms and Conditions.

Hereby, Beetronics declares that the products covered by this manual comply with the applicable EU directives. The full text of the EU Declaration of Conformity is available upon request or via the Beetronics website. For FCC and ISED compliance information, refer to Section 8.1 and 8.2 of this manual.

Issued by: Beetronics Compliance Department

Document type: Public Compliance Statement

Version: 1.5

Last updated: January 2026